



PRESTIGE

KVALITET I SIGURNOST U PROIZVODNJI
ELEKTROMATERIJALA

PRESTIGE

QUALITY AND SAFETY IN PRODUCTION
OF ELECTRICAL INSTALLATION MATERIALS



Sklopke i priključnice PRESTIGE line oplemenjene su jednostavnošću tehničkih rešenja i izuzetno lakom ugradnjom.

Izrađene su savremenim tehnološkim postupkom od visokokvalitetnih materijala.

PRESTIGE line switches and socket outlets are enriched due to their simplicity of technical solutions and very simple installation.

Products are made by modern technological process and with high quality materials.

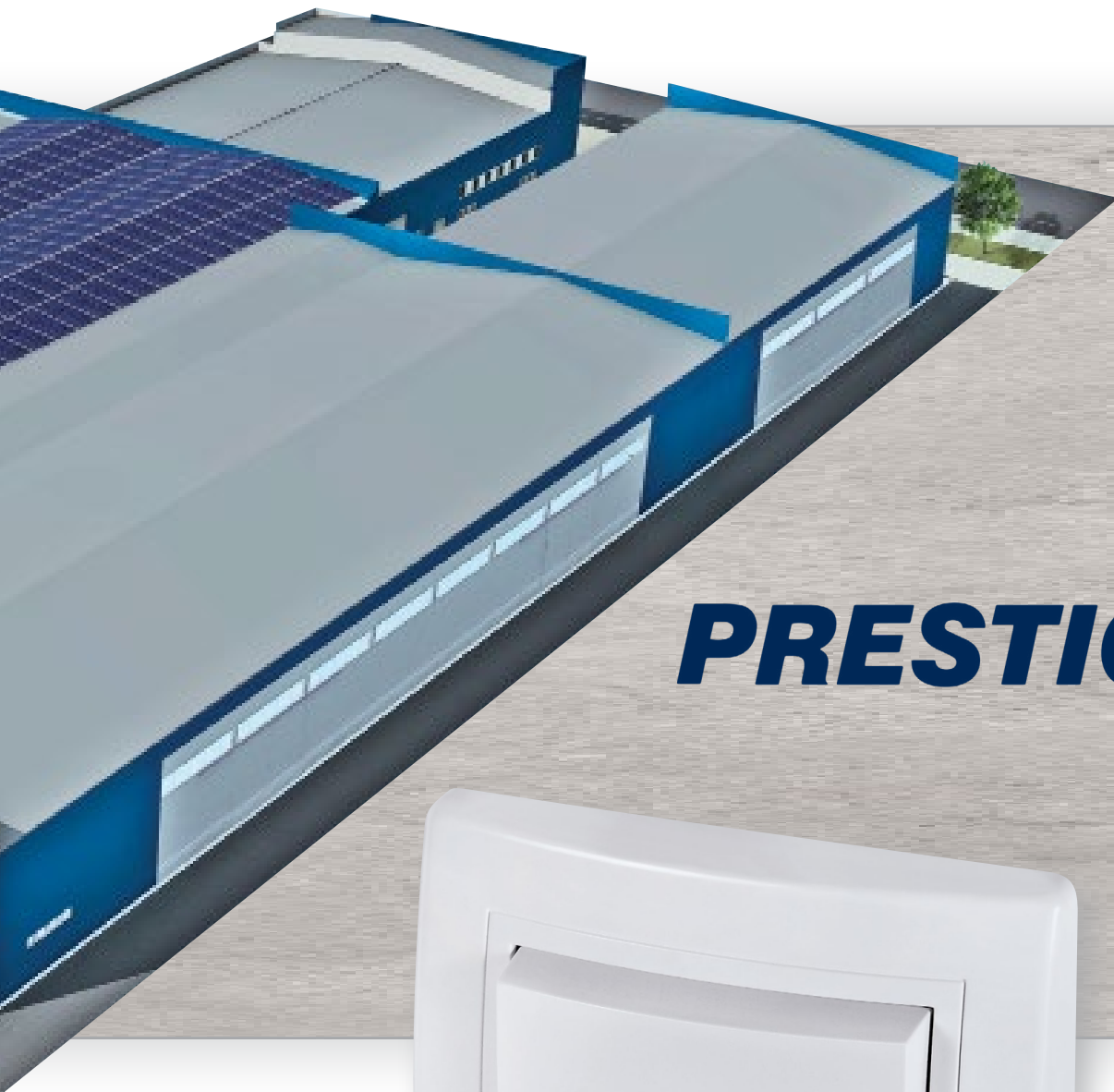

PRESTIGE



DIZAJN OBLIKUJE NAŠ SVET

PRESTIGE

DESIGN SHAPES OUR WORLD



Dizajn i boje PRESTIGE line programa savršeno se uklapaju u vaše enterijere.

Design and colours of PRESTIGE line perfectly match with your interiors.



VRLO JEDNOSTAVAN - VEOMA IZRAŽAJAN - KLASIČAN
VERY SIMPLE - VERY EXPRESSIVE - CLASICAL

PRESTIGE

TEHNIČKE PREDNOSTI TECHNICAL ADVANTAGES

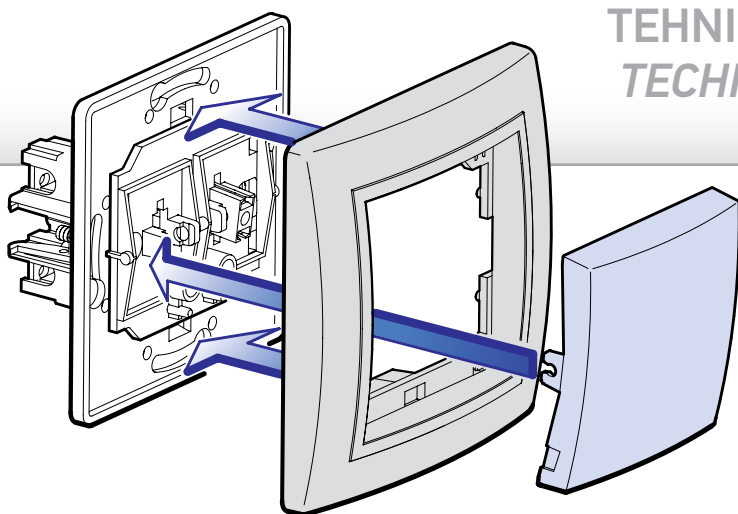

Masku i taster sklopke postavljamo i skidamo veoma jednostavno. Ova kombinacija će Vam i pored jednostavnosti obezbediti dugotrajan i pouzdan rad.
Installation of decorative cover frame and switch button is very simple and easy. Beside simplicity, this combination is providing a long and reliable usage.

BEZVIJČANA MONTAŽA SCREWLESS INSTALLATION

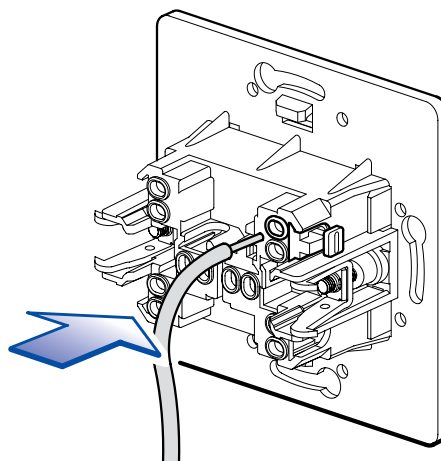

Bezvičajani kontakti omogućuju pouzdanu i brzu montažu do dva provodnika preseka 2,5 mm², bez upotrebe alata za stezanje.

Screwless contacts are allowing safe and fast installation up to two conductors with diameter 2,5 mm², without screwdriver.

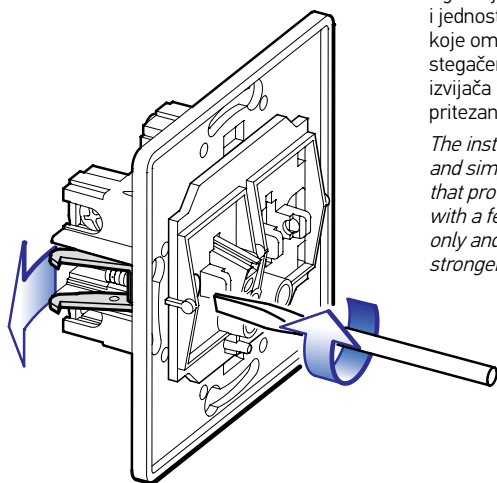

Ugradnja pomoću stegača je brza i jednostavna zahvaljujući rešenju koje omogućava pritezanje stegačem sa vrlo malo okretaja izvijača i bez potrebe jačeg pritezanja vijka.

The installation by clamps is quick and simple thanks to the solution that provides tightening by clamps with a few screwdriver turnings only and without any necessity for stronger screw tightening.

VIJČANA MONTAŽA INSTALLATION WITH SCREWS

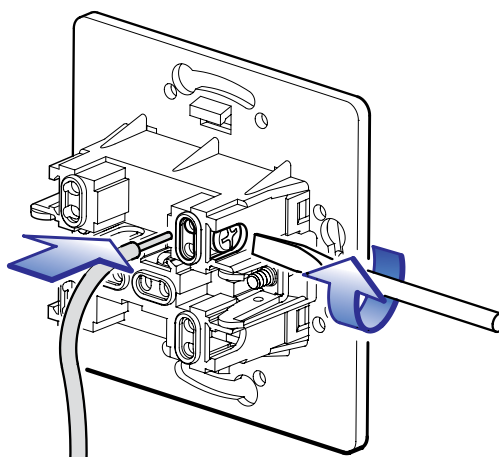

Plastična priključnica je izrađena tako da zauzima veoma malo prostora u montažnoj kutiji čime se montaža pojednostavljuje zbog većeg prostora za smeštaj provodnika.

Socket outlet is made to take a very little space in installation box. Installation is simple because of enough space for conductors.

Pritezanje provodnika obezbedeno je pouzdanom i sigurnom vijčanom vezom za provodnike preseka do 4 mm². Priključivanje provodnika je veoma brzo jer je obezbedeno njegovo postavljanje bez mogućnosti isklizavanja tokom pritezanja.

The tightening of conductors is provided by the reliable and safe screw joint for the conductors section to 4 mm². The connecting of conductors is very quick as their setting up is secured without any possibility of slipping out during tightening.

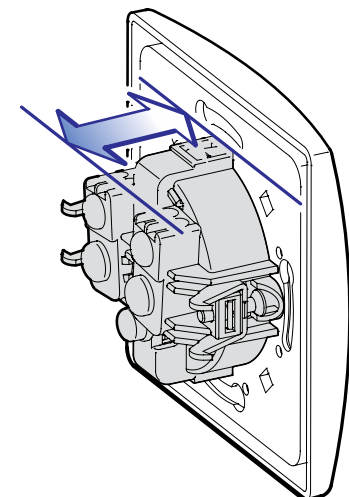

art.605.XX

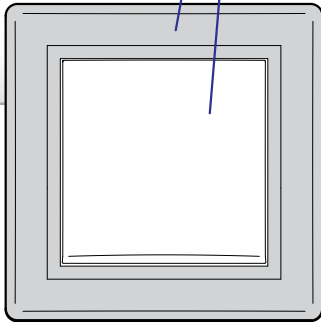

Označavanje sa 2 cifre:

prva cifra - šifra boje maske sa međuramom

druga cifra - šifra boje središnjeg dela (taster, blok)

Marking with 2 digits:

first digit - code of mask with interframe color

second digit - code of middle part color (push-button, block)

BOJE PREDNJIH ELEMENATA FRONT ELEMENTS COLORS

art.605.XXX

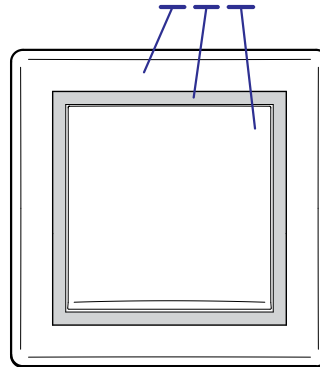

Označavanje sa 3 cifre:

prva cifra - šifra boje maske

druga cifra - šifra boje međurama

treća cifra - šifra boje središnjeg dela (taster, blok)

Marking with 3 digits:

first digit - code of mask color

second digit - code of interframe color

third digit - code of middle part color (push-button, block)

Standardno se izrađuju boje:

The standard colors are:

x = 0



Bela
White
RAL 9003

x = 1



Siva
Grey
RAL 7035

x = 2

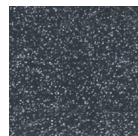

Grafit sa
metalik efektom
Graphite with
metalic efect
RAL 7021

x = 3



Bordo
Dark red
RAL 3004

x = 9



Krem
Beige
RAL 1013

x = S



Srebrna
Silver

x = E1

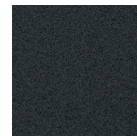

Crna Soft Touch
Black Soft Touch



000
Bela
White



S2S
Srebrna, grafit, srebrna
Silver, graphite, silver



330
Bordo, bordo, bela
Dark red, dark red, white



220
Grafit, grafit, bela
Graphite, graphite, white



212
Grafit, siva, grafit
Graphite, grey, graphite



00
Bela
White



99
Krem
Beige



E1E1
Crna Soft Touch
Black Soft Touch

Maske sa međuramom
Frames with interframe

STANDARDNE BOJE
PRESTIGE
STANDARD COLORS



Srebrna, grafit, srebrna
Silver, graphite, silver



Grafit, grafit, bela
Graphite, graphite, white



Bordo, bordo, bela
Dark red, dark red, white





Bela
White



Krem
Beige



Grafit, siva, grafit
Graphite, grey, graphite

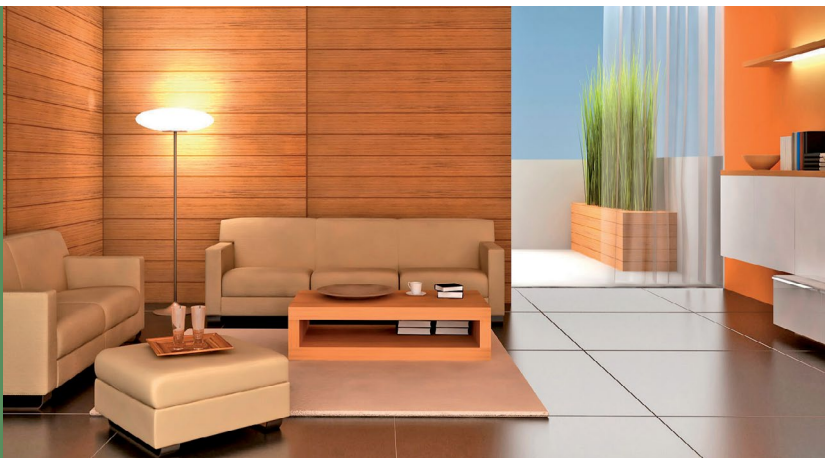

Crna Soft Touch
Black Soft Touch



PRESTIGE

SKLOPKE SWITCHES

- Usaglašeno sa IEC 60669-1
- Ugradnja u zid u montažnu kutiju Ø60 pomoću stegača ili vijaka
- Complied with IEC 60669-1
- Wall mounted into the installation box Ø60 by clamps or screws



605.xxx

Sklopka jednopolna
10AX/250V~

*Single-pole switch
10AX/250V~*

60544.xx

IP44 stepen zaštite
IP44 protection level



608.xxx

Sklopka ukrсна
10AX/250V~

*Intermediate switch
10AX/250V~*

60844.xx

IP44 stepen zaštite
IP44 protection level



6052.xxx

Sklopka dvopolna
10AX/250V~

*Double-pole switch
10AX/250V~*

605244.xx

IP44 stepen zaštite
IP44 protection level



609.xxx

Taster sklopka za svetlo
bez indikacije 10A/250V~

*Light push-button switch
without indication 10A/250V~*

60944.xx

IP44 stepen zaštite
IP44 protection level



606.xxx

Sklopka serijska
10AX/250V~

*Serial switch
10AX/250V~*

60644.xx

IP44 stepen zaštite
IP44 protection level



6091.xxx

Taster sklopka za svetlo
sa indikacijom 10A/250V~

*Light push-button switch
with indication 10A/250V~*

609144.xx

IP44 stepen zaštite
IP44 protection level

- Indikacija svetli kada je sklopka isključena
- Indication is on when the switch is off



607.xxx

Sklopka naizmjenična
10AX/250V~

*Two-way switch
10AX/250V~*

60744.xx

IP44 stepen zaštite
IP44 protection level



610.xxx

Taster sklopka za zvono
bez indikacije 10A/250V~

*Bell push-button switch
without indication 10A/250V~*

61044.xx

IP44 stepen zaštite
IP44 protection level



6072.xxx

Sklopka naizmjenična
dvostruka 10AX/250V~

*Two-way switch double
10AX/250V~*

607244.xx

IP44 stepen zaštite
IP44 protection level



6101.xxx

Taster sklopka za zvono
sa indikacijom 10A/250V~

*Bell push-button switch
with indication 10A/250V~*

610144.xx

IP44 stepen zaštite
IP44 protection level

- Indikacija svetli kada je sklopka isključena
- Indication is on when the switch is off



000

Bela
White

S2S

Srebrna, grafit, srebrna
Silver, graphite, silver



220

Grafit, grafit, bela
Graphite, graphite, white

212

Grafit, siva, grafit
Graphite, grey, graphite



330

Bordo, bordo, bela
Dark red, dark red, white

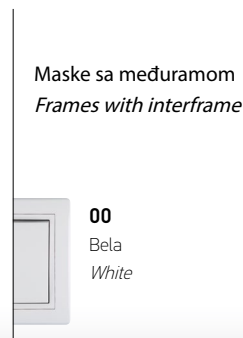

00

Bela
White



E1E1

Crna Soft Touch
Black Soft Touch

99

Krem
Beige

Maske sa međuramom
Frames with interframe



625.xxx

Sklopka jedнопolna
sa indikacijom 10AX/250V~
*Single-pole switch
with indication 10AX/250V~*

62544.xx

IP44 stepen zaštite
IP44 protection level

- Indikacija svetli kada je sklopka isključena
- *Indication is on when the switch is off*



619.xxx

Sklopka jedнопolna
sa indikacijom 16AX/250V~
*Single-pole switch
with indication 16AX/250V~*

61944.xx

IP44 stepen zaštite
IP44 protection level

- Indikacija svetli kada je sklopka isključena
- *Indication is on when the switch is off*



626.xxx

Sklopka serijska sa
indikacijom 10AX/250V~
*Serial switch with
indication 10AX/250V~*

62644.xx

IP44 stepen zaštite
IP44 protection level

- Indikacija svetli kada je sklopka isključena
- *Indication is on when the switch is off*



6191.xxx

Sklopka jedнопolna
indikatorska 16AX/250V~
*Single-pole switch
with indicator 16AX/250V~*

619144.xx

IP44 stepen zaštite
IP44 protection level

- Indikacija svetli kada je sklopka uključena
- *Indication is on when the switch is on*



627.xxx

Sklopka naizmjenična sa
indikacijom 10AX/250V~
*Two-way switch with
indication 10AX/250V~*

62744.xx

IP44 stepen zaštite
IP44 protection level

- Indikacija svetli kada je strujno kolo otvoreno
- *Indication is on when the circuit is open*



6090.xxx

Taster sklopka
10A/250V~
*Push-button
switch 10A/250V~*

609044.xx

IP44 stepen zaštite
IP44 protection level



628.xxx

Sklopka ukrсна sa
indikacijom 10AX/250V~
*Intermediate switch with
indication 10AX/250V~*

62844.xx

IP44 stepen zaštite
IP44 protection level

- Indikacija svetli kada je strujno kolo otvoreno
- *Indication is on when the circuit is open*



6075.xxx

Taster sklopka za
roletne 10A/250V~
*Rolling shutter push-button
switch 10A/250V~*

607544.xx

IP44 stepen zaštite
IP44 protection level

- Upravljanje kretanjem elektromotora za roletne u dva smera
- *Control of shutters' electric motor movement in two directions*

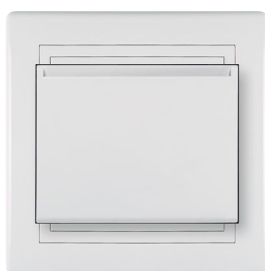

6095.xx

Taster sklopka kartična
PRESTIGE line 10A/250V~
*Push-button card switch
PRESTIGE line 10A/250V~*



6808.xx

Slepi poklopac
maske PRESTIGE
*Mask cover
PRESTIGE, complete
with frame*



6092.xx

Taster sklopka
serijska 10A/250V~
*Serial push-button
switch 10A/250V~*

609244.xx

IP44 stepen zaštite
IP44 protection

PRESTIGE

REGULATORI JAČINE SVETLOSTI DIMMERS



617.xxx

Regulator jačine svetlosti sa naizmjeničnom sklopkom 40-400VA, 230V~/50Hz

Dimmer with two-way switch 40-400VA, 230V~/50Hz

- Za sijalice sa užarenim vlaknom i halogene sijalice sa standardnim transformatorom
- Usaglašeno sa IEC 60669-2-1
- Ugradnja u zid u montažnu kutiju Ø60 pomoću stegača ili vijaka

- *For incandescent filament lamps and halogen lamps with standard transformer*
- *Complied with IEC 60669-2-1*
- *Wall mounted into the installation box Ø60 by clamps or screws*



6173.xxx

Regulator jačine svetlosti sa rotacionom jednopolnom sklopkom 40-400VA, 230V~/50Hz

Dimmer with rotary single-pole switch 40-400VA, 230V~/50Hz

- Za sijalice sa užarenim vlaknom i halogene sijalice sa standardnim transformatorom
- Usaglašeno sa IEC 60669-2-1
- Ugradnja u zid u montažnu kutiju Ø60 pomoću stegača ili vijaka

- *For incandescent filament lamps and halogen lamps with standard transformer*
- *Complied with IEC 60669-2-1*
- *Wall mounted into the installation box Ø60 by clamps or screws*



6175.xxx

Regulator jačine svetlosti za LED, 1-100W

Dimmer for LED, 1-100W

- Univerzalni elektronski regulator za sve vrste sijalica
- Osnovna namena za CFL i LED dimabilne sijalice 1-100W
- Usaglašeno sa IEC 60669-2-1

- *Universal dimmer for all types of bulbs*
- *The main purpose for dimmable CFL and LED bulbs 1-100W*
- *Complied with IEC 60669-2-1*

IZLAZ KABLA / CABLE OUTLET

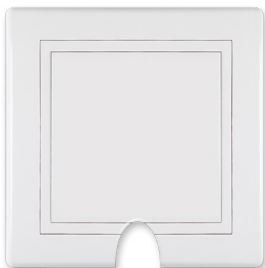

640.x

Izlaz kablova PRESTIGE 5x2,5mm² 450V

Cable outlet PRESTIGE 5x2,5mm² 450V, complete with frame



641.xx 641.xxx

Izlaz kablova PRESTIGE
Cable outlet PRESTIGE, complete with frame



642.xx 642.xxx

Izlaz kablova sa stezaljkama PRESTIGE, 3x2,5 mm² 450V
Cable outlet with terminals PRESTIGE, 3x2,5 mm² 450V, complete with frame

PRESTIGE

- Usaglašeno sa IEC 60884-1
- Ugradnja u zid u montažnu kutiju Ø60 pomoću stegača ili vijaka

- Complied with IEC 60884-1
- Wall mounted into the installation box Ø60 by clamps or screws

PRIKLJUČNICE SOCKET OUTLETS



600.xxx

Priključnica dvopolna 16A/250V~
sa porcelanskim jezgrom
*Double-pole socket outlet 16A/250V~
with porcelain insert*



603.xxx

Priključnica dvopolna
sa poklopcem 16A/250V~
sa porcelanskim jezgrom
*Double-pole socket outlet
with cover 16A/250V~
with porcelain insert*



601.xxx

Priključnica dvopolna 16A/250V~
sa porcelanskim jezgrom
i zaštitom od dodira
*Double-pole socket outlet
16A/250V~ with porcelain insert
and touch protection*



633.xxx

Priključnica dvopolna
sa poklopcem 16A/250V~
sa polikarbonatskim jezgrom
*Double-pole socket outlet
with cover 16A/250V~
with polycarbonate insert*



630.xxx

Priključnica dvopolna 16A/250V~
sa polikarbonatskim jezgrom
*Double-pole socket outlet 16A/250V~
with polycarbonate insert*



623.xx

Priključnica dvopolna
16A/250V~, **IP44** sa
polikarbonatskim jezgrom
*Double-pole socket outlet
16A/250V~ IP44 with
polycarbonate insert*



604.xx

Priključnica dvopolna
dvostruka 16A/250V~
sa polikarbonatskim jezgrom
*Double-pole socket outlet
16A/250V~ double
with polycarbonate insert*

- Nema mogućnost ugradnje u višestruke maske
- No possibility of mounting into multiple masks



602.xx

Priključnica trolna 16A/440V~
sa porcelanskim jezgrom
*Tripolar socket outlet 16A/440V~
with porcelain insert*

- Ugradnja u zid u montažnu kutiju Ø70 pomoću vijaka
- Wall mounted into the installation box Ø70 by screws



6021.xx

Priključnica trolna 16A/440V~
sa polikarbonatskim jezgrom
*Tripolar socket outlet 16A/440V~
with polycarbonate insert*

- Ugradnja u zid u montažnu kutiju Ø70 pomoću vijaka
- Wall mounted into the installation box Ø70 by screws

PRESTIGE

PRIKLJUČNICE SOCKET OUTLETS



630.04

Priključnica dvopolna 16A/250V~ sa polikarbonatskim jezgrom
Za mreže sa UPS (sa transformatorom) - crvena

*Double-pole socket outlet 16A/250V~ with polycarbonate insert
For power networks with UPS (with transformer) - red*



630.0N

Priključnica dvopolna 16A/250V~ sa polikarbonatskim jezgrom
Za mreže sa generatorskim napajanjem preko transformatora - narandžasta

*Double-pole socket outlet 16A/250V~ with polycarbonate insert
For power networks with generator supply via transformer - orange*



630.012

Priključnica dvopolna 16A/250V~ sa polikarbonatskim jezgrom
Za mreže sa zaštićenim generatorskim napajanjem - zelena

*Double-pole socket outlet 16A/250V~ with polycarbonate insert
For power networks with protected generator supply via transformer - green*



6045.xx

Priključnica dvopolna dvostruka 16A/250V~ sa polikarbonatskim jezgrom
Francuski standard

*Double-pole socket outlet 16A/250V~ double with polycarbonate insert
French standard*

- Nema mogućnost ugradnje u višestruke maske
- Usaglašeno sa IEC 60884-1, NF C 61-314
- *No possibility of mounting into multiple masks*
- *Complied with IEC 60884-1, NF C 61-314*



635.xxx

Priključnica dvopolna 16A/250V~
Francuski standard

*Double-pole socket outlet 16A/250V~
French standard*

- Nema mogućnost ugradnje u višestruke maske
- Usaglašeno sa IEC 60884-1, NF C 61-314
- *No possibility of mounting into multiple masks*
- *Complied with IEC 60884-1, NF C 61-314*



6350.xxx

Priključnica dvopolna 16A/250V~ sa zaštitom od dodira
Francuski standard

*Double-pole socket outlet 16A/250V~ with touch protection
French standard*

- Nema mogućnost ugradnje u višestruke maske
- Usaglašeno sa IEC 60884-1, NF C 61-314
- *No possibility of mounting into multiple masks*
- *Complied with IEC 60884-1, NF C 61-314*



6161.xxx

USB A punjač 2 x USB 2,1A/5V=
2 x USB A charger 2,1A/5V=

- Za punjenje elektronskih uređaja putem standardnog USB porta
- Punjenje dva uređaja istovremeno
- Usaglašeno sa EN 60950-1 EMC direktivom
- *For charging of electronic devices via standard USB port*
- *Enables charging of two devices simultaneously*
- *Complied with EN 60950-1 and EMC directive*



6162.xxx

Priključnica USB/USB Keystone
USB/USB socket Keystone

- Za konekciju USB uređaja i kablova (nije punjač)
- Podržava USB 2.0 standard
- *For connection of USB devices and cables (not charging unit)*
- *Supports USB 2.0 standard*



6166.xxx

USB C punjač 3A/5V=
USB C charger 3A/5V=

- Za punjenje elektronskih uređaja putem USB C porta
- Usaglašeno sa EN 60950-1 EMC direktivom
- *For charging of electronic devices via USB C port*
- *Complied with EN 60950-1 and EMC directive*



6163.xxx

Priključnica HDMI/HDMI Keystone
HDMI/HDMI socket Keystone

- Za konekciju kablova za prenos signala preko HDMI priključka
- *For the transmission of signal through HDMI connector*

PRESTIGE

KOMUNIKACIJE COMMUNICATIONS

- Usaglašeno sa IEC 60603-7
- Ugradnja u zid u montažnu kutiju Ø60 pomoću stegača ili vijaka
- Complied with IEC 60603-7
- Wall mounted into the installation box Ø60 by clamps or screws



611.xxx

Priključnica telefonska dvostruka RJ12 6/2 sa dve odvojene linije

Double telephone socket RJ12 6/2 with two separate lines



613.xxx RJ12 6/4 Cat3

6131.xxx RJ12 6/6 Cat3

Priključnica telefonska dvostruka sa Keystone modulima

Double telephone socket with Keystone modules

- Montaža provodnika bez upotrebe alata
- Toolless conducting wire installation



614.xxx

Priključnica komunikacijska sa Keystone modulima dvostruka RJ45 Cat5e UTP

Data socket double with Keystone modules RJ45 Cat5e UTP

- Montaža provodnika bez upotrebe alata
- Spajanje prema TIA/EIA-568A ili 568B standardu za raspored parica
- Toolless conducting wire installation
- Wiring according to TIA/EIA-568A or 568B standard for the arrangement of pairs



614S.xxx

Priključnica komunikacijska sa Keystone modulima dvostruka RJ45 Cat5e FTP

Data socket double with Keystone modules RJ45 Cat5e FTP (shielded)

- Montaža provodnika bez upotrebe alata
- Spajanje prema TIA/EIA-568A ili 568B standardu za raspored parica
- Toolless conducting wire installation
- Wiring according to TIA/EIA-568A or 568B standard for the arrangement of pairs



615.xxx

Priključnica komunikacijska sa Keystone modulima dvostruka RJ45 Cat6 UTP

Data socket double with Keystone modules RJ45 Cat6 UTP

- Montaža provodnika bez upotrebe alata
- Spajanje prema TIA/EIA-568A ili 568B standardu za raspored parica
- Toolless conducting wire installation
- Wiring according to TIA/EIA-568A or 568B standard for the arrangement of pairs



615S.xxx

Priključnica komunikacijska sa Keystone modulima dvostruka RJ45 Cat6 FTP

Data socket double with Keystone modules RJ45 Cat6 FTP (shielded)

- Montaža provodnika bez upotrebe alata
- Spajanje prema TIA/EIA-568A ili 568B standardu za raspored parica
- Toolless conducting wire installation
- Wiring according to TIA/EIA-568A or 568B standard for the arrangement of pairs



616.xxx

Priključnica komunikacijska sa Keystone modulom RJ45 Cat6A UTP

Data socket with Keystone module RJ45 Cat6A UTP

- Montaža provodnika bez upotrebe alata
- Spajanje prema TIA/EIA-568A ili 568B standardu za raspored parica
- Toolless conducting wire installation
- Wiring according to TIA/EIA-568A or 568B standard for the arrangement of pairs



616S.xxx

Priključnica komunikacijska sa Keystone modulom RJ45 Cat6A FTP

Data socket with Keystone module RJ45 Cat6A FTP (shielded)

- Montaža provodnika bez upotrebe alata
- Spajanje prema TIA/EIA-568A ili 568B standardu za raspored parica
- Toolless conducting wire installation
- Wiring according to TIA/EIA-568A or 568B standard for the arrangement of pairs



PRESTIGE

KOMUNIKACIJE COMMUNICATIONS

- Usaglašeno sa IEC 60169-2
- Ugradnja u zid u montažnu kutiju Ø60 pomoću stegača ili vijaka
- Complied with IEC 60169-2
- Wall mounted into the installation box Ø60 by clamps or screws



612I.xxx

Priključnica antenska TV završna za individualne sisteme

TV aerial socket for individual systems

- Muški konektor
- Odvodno slabljenje signala <1 dB
- Male connector
- Connection attenuation <1 dB



612P.xxx

Priključnica antenska TV/FM prolazna
TV/FM aerial socket transient

- Muški konektor TV, ženski konektor FM
- Prolazno slabljenje 4 dB, odvodno 6 dB, sprega TV/FM >20 dB
- Male connector TV, female connector FM
- Throughpass attenuation 4 dB, connection atten. 6 dB, coupling TV/FM >20 dB



612Z.xxx

Priključnica antenska TV/FM završna

TV/FM aerial socket terminal

- Muški konektor TV, ženski konektor FM
- Odvodno slabljenje <2 dB, sprega TV/FM >20 dB
- Male connector TV, female connector FM
- Connection attenuation <2 dB, coupling attenuation TV/FM >20 dB



612S.xxx

Priključnica antenska TV/FM/SAT završna

TV/FM/SAT aerial socket terminal

- Muški konektor TV, ženski konektor FM
- SAT konektor IEC 60169-24 (F tip)
- Odvodno slabljenje <2 dB, sprega TV/FM >20 dB
- Male connector TV, male connector FM
- SAT connector IEC 60169-24 (F type)
- Connection attenuation <2 dB, coupling attenuation TV/FM >20 dB



000
Bela
White



S2S
Srebrna, grafit, srebrna
Silver, graphite, silver



220
Grafit, grafit, bela
Graphite, graphite, white



212
Grafit, siva, grafit
Graphite, grey, graphite



330
Bordo, bordo, bela
Dark red, dark red, white



00
Bela
White

Maske sa međuramom
Frames with interframe



E1E1
Crna Soft Touch
Black Soft Touch



99
Krem
Beige

PRESTIGE

MEHANIZMI BEZ MASKE I MEĐURAMA
MECHANISMS WITHOUT COVER FRAME AND INTERFRAME

PRESTIGE



Za ugradnju u višestruke maske proizvodi PRESTIGE line isporučuju se bez pripadajuće maske i međurama, čime je omogućeno da korisnik sam kombinuje boje i grupisanje komponenti. Uz svaki mehanizam isporučuje se taster ili blok u standardnim bojama.

For the installation into the multiple masks, the products of PRESTIGE line are supplied without the pertaining frame and interframe thus enabling the user to make the combination of colours and grouping of components. Each mechanism is supplied with button or the block in standard colours.

- Usaglašeno sa IEC 60669-1
- Ugradnja u zid u montažnu kutiju Ø60 pomoću stegača ili vijaka

- Complied with IEC 60669-1
- Wall mounted into the installation box Ø60 by clamps or screws



6005.x

Sklopka jednopolna
10AX/250V~

*Single-pole switch
10AX/250V~*



6009.x

Taster sklopka za svetlo
bez indikacije
10A/250V~

*Light push-button switch
without indication
10A/250V~*



60052.x

Sklopka dvopolna
10AX/250V~

*Double-pole switch
10AX/250V~*



60091.x

Taster sklopka za svetlo
sa indikacijom 10A/250V~

*Light push-button switch
with indication 10A/250V~*

- Indikacija svetli kada je sklopka isključena
- *Indication is on when the switch is off*

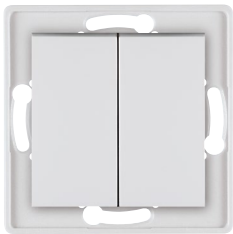

6006.x

Sklopka serijska
10AX/250V~

*Serial switch
10AX/250V~*

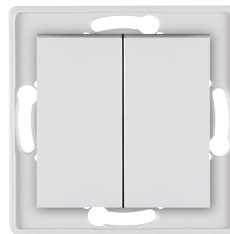

60092.x

Taster sklopka serijska
10A/250V~

*Serial push-button switch
10A/250V~*

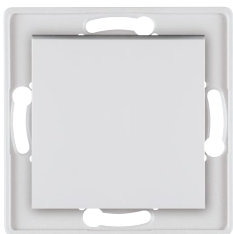

6007.x

Sklopka naizmjenična
10AX/250V~

*Two-way switch
10AX/250V~*

6008.x

Sklopka ukrсна
10AX/250V~

*Intermediate switch
10AX/250V~*



6010.x

Taster sklopka za zvono
bez indikacije
10A/250V~

*Bell push-button switch
without indication
10A/250V~*

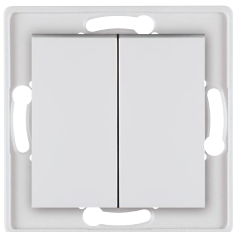

60072.x

Sklopka naizmjenična
dvostruka 10AX/250V~

*Two-way switch double
10AX/250V~*



60101.x

Taster sklopka za zvono
sa indikacijom 10A/250V~

*Bell push-button switch
with indication 10A/250V~*

- Indikacija svetli kada je sklopka isključena
- *Indication is on when the switch is off*



60090.x

Taster sklopka
10A/250V~

*Push-button switch
10A/250V~*

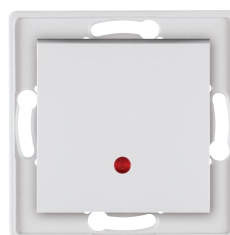

6025.x

Sklopka jednopolna
sa indikacijom 10AX/250V~

*Single-pole switch
with indication 10AX/250V~*

- Indikacija svetli kada je sklopka isključena
- *Indication is on when the switch is off*

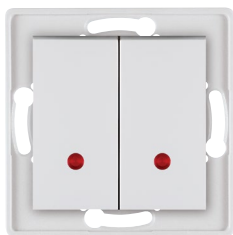

6026.x

Sklopka serijska sa indicijom 10AX/250V~
Serial switch with indication 10AX/250V~

- Indikacija svetli kada je sklopka isključena
- *Indication is on when the switch is off*

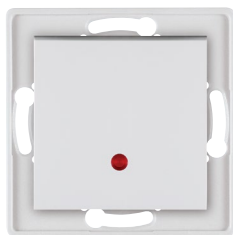

6027.x

Sklopka naizmjenična sa indicijom 10AX/250V~
Two-way switch with indication 10AX/250V~

- Indikacija svetli kada je strujno kolo otvoreno
- *Indication is on when the circuit is open*

6028.x

Sklopka ukrсна sa indicijom 10AX/250V~
Intermediate switch with indication 10AX/250V~

- Indikacija svetli kada je strujno kolo otvoreno
- *Indication is on when the circuit is open*

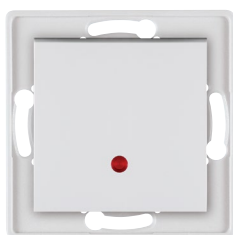

6019.x

Sklopka jednopolna sa indicijom 16AX/250V~
Single-pole switch with indication 16AX/250V~

- Indikacija svetli kada je strujno kolo otvoreno
- *Indication is on when the circuit is open*

60191.x

Sklopka jednopolna indikatorска 16AX/250V~
Single-pole switch with indicator 16AX/250V~

- Indikacija svetli kada je sklopka uključena
- *Indication is on when the switch is on*

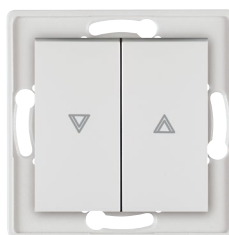

60075.x

Taster sklopka za roletne 10A/250V~
Rolling shutter push-button switch 10A/250V~

- Upravljanje kretanjem elektromotora za roletne u dva smera
- *Control of shutters' electric motor movement in two directions*

• Usaglašeno sa IEC 60884-1

• Ugradnja u zid u montažnu kutiju Ø60 pomoću stegača ili vijaka

• *Complied with IEC 60884-1*

• *Wall mounted into the installation box Ø60 by clamps or screws*

• Usaglašeno sa IEC 60670-1 i IEC 60670-22

• Ugradnja u zid u montažnu kutiju Ø60 pomoću stegača ili vijaka

• *Complied with IEC 60670-1 and IEC 60670-22*

• *Wall mounted into the installation box Ø60 by clamps or screws*



6000.x

Priključnica dvopolna 16A/250V~ sa porcelanskim jezgrom
Double-pole socket outlet 16A/250V~ with porcelain insert



6003.x

Priključnica dvopolna sa poklopcem 16A/250V~ sa porcelanskim jezgrom
Double-pole socket outlet with cover 16A/250V~ with porcelain insert

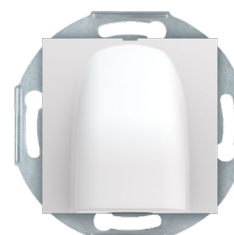

6041.x

Izlaz kabla PRESTIGE
Cable outlet PRESTIGE, without frame



6001.x

Priključnica dvopolna 16A/250V~ sa porcelanskim jezgrom i zaštitom od dodira
Double-pole socket outlet 16A/250V~ with porcelain insert and touch protection



6033.x

Priključnica dvopolna sa poklopcem 16A/250V~ sa polikarbonatskim jezgrom
Double-pole socket outlet with cover 16A/250V~ with polycarbonate insert

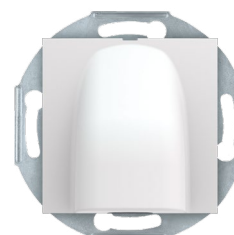

6042.x

Izlaz kabla sa stezaljkama PRESTIGE 3x2,5mm² 450V
Cable outlet with terminals PRESTIGE, 3x2,5mm² 450V, without frame



6030.x

Priključnica dvopolna 16A/250V~ sa polikarbonatskim jezgrom
Double-pole socket outlet 16A/250V~ with polycarbonate insert



6035.x

Priključnica dvopolna 16A/250V~ Francuski standard
Double-pole socket outlet 16A/250V~ French standard

- Usaglašeno sa NF C 61-314
- *Complied with NF C 61-314*



6030.4

6030.N

6030.12



60350.x

Priključnica dvopolna 16A/250V~ sa zaštitom od dodira Francuski standard
Double-pole socket outlet 16A/250V~ with touch protection French standard

- Usaglašeno sa NF C 61-314
- *Complied with NF C 61-314*

- Usaglašeno sa IEC 60669-2-1
- Ugradnja u zid u montažnu kutiju Ø60 pomoću stegača ili vijaka

- *Complied with IEC 60669-2-1*
- *Wall mounted into the installation box Ø60 by clamps or screws*

- Usaglašeno sa IEC 60603-7
- Ugradnja u zid u montažnu kutiju Ø60 pomoću stegača ili vijaka



6017.x

Regulator jačine svetlosti sa naizmeničnom sklopkom 40-400VA, 230V~/50Hz

Dimmer with two-way switch 40-400VA, 230V~/50Hz

- Za sijalice sa užarenim vlaknom i halogene sijalice sa standardnim transformatorom,
- *For incandescent filament lamps and halogen lamps with standard transformer*



6011.x

Priključnica telefonska dvostruka RJ12 6/2 sa dve odvojene linije

Double telephone socket RJ12 6/2 with two separate lines



60173.x

Regulator jačine svetlosti sa rotacionom jednopolnom sklopkom 40-400VA, 230V~/50Hz

Dimmer with rotary single-pole switch 40-400VA, 230V~/50Hz

- Za sijalice sa užarenim vlaknom i halogene sijalice sa standardnim transformatorom,
- *For incandescent filament lamps and halogen lamps with standard transformer*



6013.x

Priključnica telefonska dvostruka sa Keystone modulima RJ12 6/4 Cat 3

Double telephone socket with Keystone modules RJ12 6/4 Cat 3

- Montaža provodnika bez upotrebe alata
- *Toolless conducting wire installation*



60175.x

Regulator jačine svetlosti za LED, 100W

Dimmer for LED, 100W

- Univerzalni elektronski regulator za sve vrste sijalica;
- Osnovna namena za CFL i LED dimabilne sijalice 0-100W;
- *Universal dimmer for all types of bulbs;*
- *The main purpose for dimmable CFL and LED bulbs 0-100W;*



60131.x

Priključnica telefonska dvostruka sa Keystone modulima RJ12 6/6 Cat 3

Double telephone socket with Keystone modules RJ12 6/6 Cat 3

- Montaža provodnika bez upotrebe alata
- *Toolless conducting wire installation*

- Usaglašeno sa EN 60950-1 EMC direktivom;
- Ugradnja u zid u montažnu kutiju Ø60 pomoću stegača ili vijaka

- *Complied with EN 60950-1 and EMC directive;*
- *Wall mounted into the installation box Ø60 by clamps or screws*



60161.x

USB A punjač 2 x USB 2,1A 5V=

2 x USB A charger 2,1A 5V=

- Za punjenje elektronskih uređaja putem standardnog USB porta;
- Punjenje dva uređaja istovremeno;
- *For charging of electronic devices via standard USB port;*
- *Enables charging of two devices simultaneously;*



60166.x

USB C punjač 3A 5V=

USB C charger 3A 5V=

- Za punjenje elektronskih uređaja putem USB C porta;
- Usaglašeno sa EN 60950-1 EMC direktivom;
- *For charging of electronic devices via USB C port;*
- *Complied with EN 60950-1 and EMC directive;*



60162.x

Priključnica USB/USB Keystone

USB/USB socket Keystone

- Za konekciju USB uređaja i kablova (nije punjač);
- Podržava USB 2.0 standard;
- *For connection of USB devices and cables (not charging unit);*
- *Supports USB 2.0 standard;*



60163.x

Priključnica HDMI/HDMI Keystone

HDMI/HDMI socket Keystone

- Za konekciju kablova za prenos signala preko HDMI priključka;
- *For the transmission of signal through HDMI connector;*

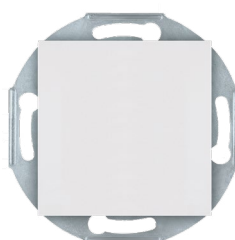

60808.x

Slepi poklopac maske PRESTIGE

Mask cover PRESTIGE, without frame

- Complied with IEC 60603-7
- Wall mounted into the installation box Ø60 by clamps or screws

- Usaglašeno sa IEC 60169-2
- Ugradnja u zid u montažnu kutiju Ø60 pomoću stegača ili vijaka

- Complied with IEC 60169-2
- Wall mounted into the installation box Ø60 by clamps or screws



6014.x

Priključnica komunikacijska sa Keystone modulima dvostruka RJ45 Cat5e UTP

Data socket double with Keystone modules RJ45 Cat5e UTP



6012I.x

Priključnica antenska TV završna za individualne sisteme

TV aerial socket for individual systems

- Muški konektor
- Odvodno slabljenje signala <1 dB
- Male connector
- Connection attenuation <1 dB



6014S.x

Priključnica komunikacijska sa Keystone modulima dvostruka RJ45 Cat5e FTP

Data socket double with Keystone modules RJ45 Cat5e FTP



6012Z.x

Priključnica antenska TV/FM završna TV/FM aerial socket terminal

- Muški konektor TV, ženski konektor FM
- Odvodno slabljenje <2 dB, sprega TV/FM >20 dB
- Male connector TV, female connector FM
- Connection attenuation <2 dB, coupling attenuation TV/FM >20 dB



6015.x

Priključnica komunikacijska sa Keystone modulima dvostruka RJ45 Cat6 UTP

Data socket double with Keystone modules RJ45 Cat6 UTP



6012P.x

Priključnica antenska TV/FM prolazna TV/FM aerial socket transient

- Muški konektor TV, ženski konektor FM
- Prolazno slabljenje 4 dB, odvodno 6 dB, sprega TV/FM >20 dB
- Male connector TV, female connector FM
- Throughpass attenuation 4 dB, connection atten. 6 dB, coupling TV/FM >20 dB



6015S.x

Priključnica komunikacijska sa Keystone modulima dvostruka RJ45 Cat6 FTP

Data socket double with Keystone modules RJ45 Cat6 FTP

- Montaža provodnika bez upotrebe alata
- Spajanje prema TIA/EIA-568A ili 568B standardu za raspored parica
- Toolless conducting wire installation
- Wiring according to TIA/EIA-568A or 568B standard for the arrangement of pairs

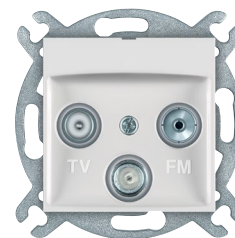

6012S.x

Priključnica antenska TV/FM/SAT završna

TV/FM/SAT aerial socket terminal

- Muški konektor TV, ženski konektor FM
- SAT konektor IEC 60169-24 (F tip)
- Odvodno slabljenje <2 dB, sprega TV/FM >20 dB
- Male connector TV, male connector FM
- SAT connector IEC 60169-24 (F type)
- Connection attenuation <2 dB, coupling attenuation TV/FM >20 dB



6016.x

Priključnica komunikacijska sa Keystone modulom RJ45 Cat6A UTP

Data socket with Keystone module RJ45 Cat6A UTP

- Montaža provodnika bez upotrebe alata
- Spajanje prema TIA/EIA-568A ili 568B standardu za raspored parica
- Toolless conducting wire installation
- Wiring according to TIA/EIA-568A or 568B standard for the arrangement of pairs



6016S.x

Priključnica komunikacijska sa Keystone modulom RJ45 Cat6A FTP

Data socket with Keystone module RJ45 Cat6A FTP (shielded)

- Montaža provodnika bez upotrebe alata
- Spajanje prema TIA/EIA-568A ili 568B standardu za raspored parica
- Toolless conducting wire installation
- Wiring according to TIA/EIA-568A or 568B standard for the arrangement of pairs

 Bela White **x = 0**

 Grafit Graphite **x = 2**

 Bordo Dark red **x = 3**

 Crna Soft Touch Black Soft Touch **x = E1**

 Krem Beige **x = 9**

 Srebrna Silver **x = S**

PRESTIGE

MASKE I MEĐURAMOVI COVER FRAMES AND INTERFRAMES

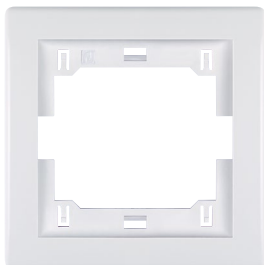

6801.x

Maska jednostruka
PRESTIGE line

*One-gang frame
PRESTIGE line*

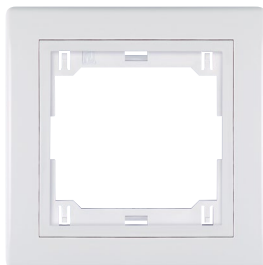

6811.xx

Maska jednostruka
sa međuramom
PRESTIGE line

*One-gang frame
with interframe
PRESTIGE line*

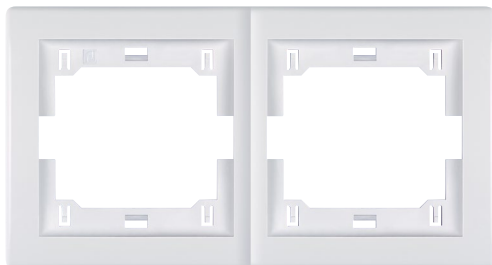

6701.x

Maska dvostruka
PRESTIGE line
horizontalna

*Two-gang frame
PRESTIGE line
horizontal*

6701.xx

Maska dvostruka
sa međuramom
PRESTIGE line
horizontalna

*Two-gang frame
with interframe
PRESTIGE line
horizontal*

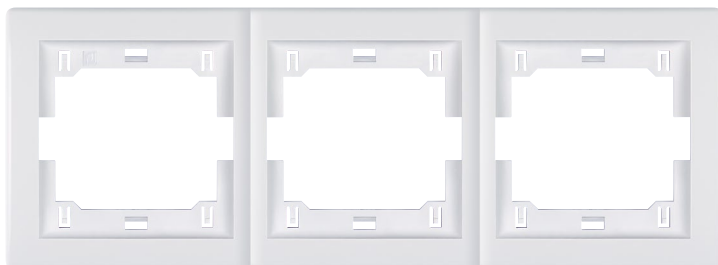

6703.x

Maska trostruka
PRESTIGE line
horizontalna

*Three-gang frame
PRESTIGE line
horizontal*

6703.xx

Maska trostruka
sa međuramom
PRESTIGE line
horizontalna

*Three-gang frame
with interframe
PRESTIGE line
horizontal*

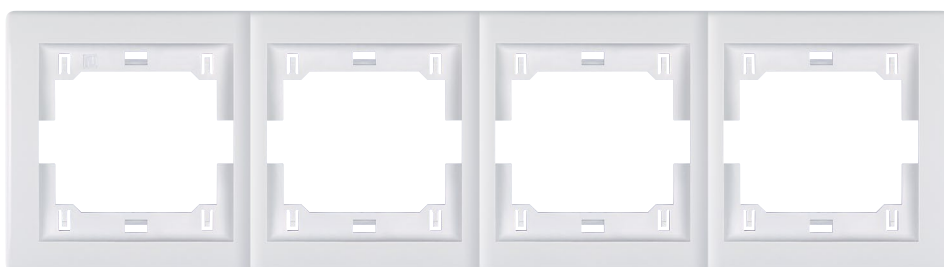

6704.x

Maska četvostruka
PRESTIGE line
horizontalna

*Four-gang frame
PRESTIGE line
horizontal*

6704.xx

Maska četvostruka
sa međuramom
PRESTIGE line
horizontalna

*Four-gang frame
with interframe
PRESTIGE line
horizontal*

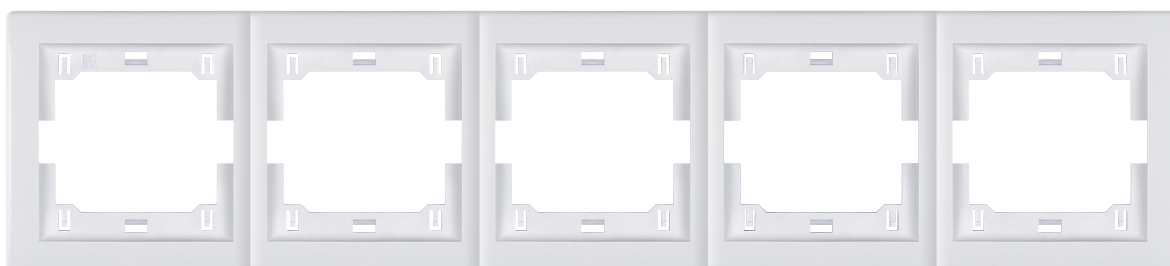

6705.x

Maska petostruka
PRESTIGE line - horizontalna

*Five-gang frame
PRESTIGE line - horizontal*

6705.xx



Maska petostruka
sa međuramom
PRESTIGE line - horizontalna

*Five-gang frame
with interframe
PRESTIGE line - horizontal*

- Usaglašeno sa IEC 60669-1 i IEC 60884-1
- Za ugradnju na PRESTIGE LINE mehanizme ugrađene u zid u nizajuće dozne za višestruke maske (osno rastojanje 71 mm)
- *Complied with IEC 60669-1 and IEC 60884-1*
- *For mounting onto PRESTIGE LINE mechanisms wall mounted in a sequence of boxes for multiple masks (axial distance 71 mm)*

	Bela White	x = 0
	Srebrna Silver	x = S
	Grafit Graphite	x = 2
	Bordo Dark red	x = 3

Maske sa međuramom
Frames with interframe

	Bela White	xx = 00
	Krem Beige	xx = 99
	Crna Soft Touch Black Soft Touch	xx = E1E1

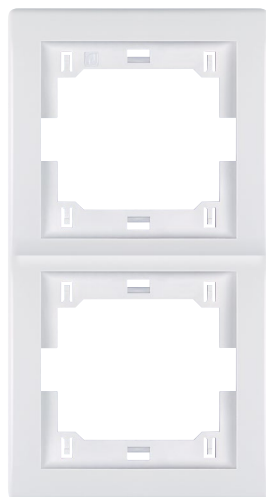

6711.x

Maska dvostruka
PRESTIGE line
vertikalna

*Two-gang frame
PRESTIGE line
vertical*

6711.xx

Maska dvostruka
sa međuramom
PRESTIGE line
vertikalna

*Two-gang frame
with interframe
PRESTIGE line
vertical*

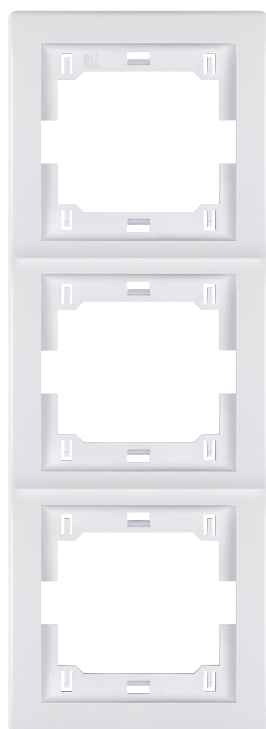

6713.x

Maska trostruka
PRESTIGE line
vertikalna

*Three-gang frame
PRESTIGE line
vertical*

6713.xx

Maska trostruka
sa međuramom
PRESTIGE line
vertikalna

*Three-gang frame
with interframe
PRESTIGE line
vertical*

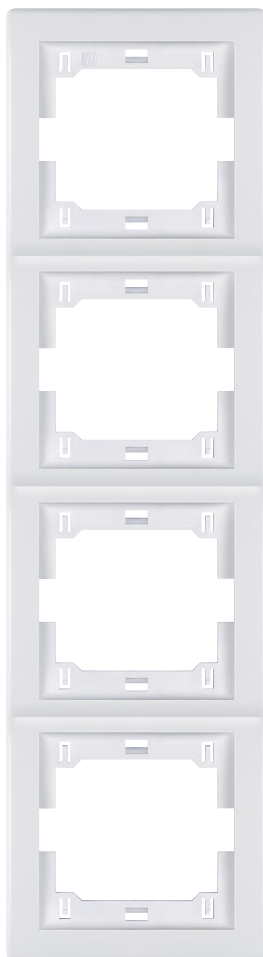

6714.x

Maska četvostruka
PRESTIGE line - vertikalna

*Four-gang frame
PRESTIGE line - vertical*

6714.xx

Maska četvostruka sa međuramom
PRESTIGE line - vertikalna

*Four-gang frame with interframe
PRESTIGE line - vertical*

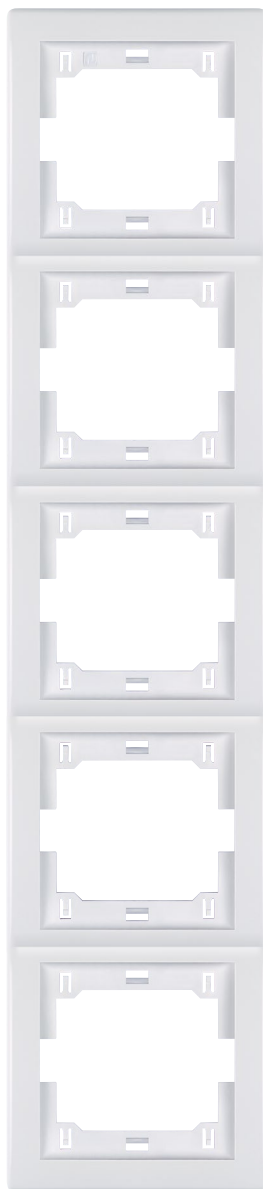

6715.x

Maska petostruka
PRESTIGE line
vertikalna

*Five-gang frame
PRESTIGE line
vertical*

6715.xx

Maska petostruka
sa međuramom
PRESTIGE line
vertikalna

*Five-gang frame
with interframe
PRESTIGE line
vertical*

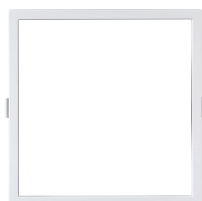

6802.x

Međuram PRESTIGE line
Interframe PRESTIGE line

- Usaglašeno sa IEC 60669-1 i IEC 60884-1
- Za ugradnju na PRESTIGE line maske kao ukrasni element
- *Complied with IEC 60669-1 and IEC 60884-1*
- *For mounting onto PRESTIGE line frames, like decorative element*

Beli	6802.0	White
Sivi	6802.1	Grey
Grafit	6802.2	Graphite
Bordo	6802.3	Dark red
Crveni	6802.4	Red
Svetlo plavi	6802.5	Light blue
Teget	6802.6	Navy-blue
Svetlo zeleni	6802.7	Light green
Žuti	6802.8	Yellow
Krem	6802.9	Beige
Roze	6802.10	Pink
Zeleni	6802.12	Green
Srebrni	6802.S	Silver
Crni Soft Touch	6802.E1	Black Soft Touch

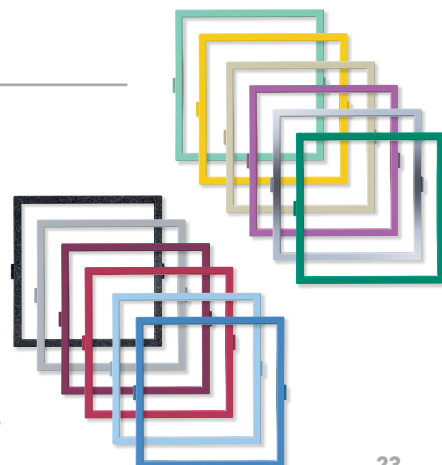



PRESTIGE

ŠEME VEZIVANJA WIRING DIAGRAMS

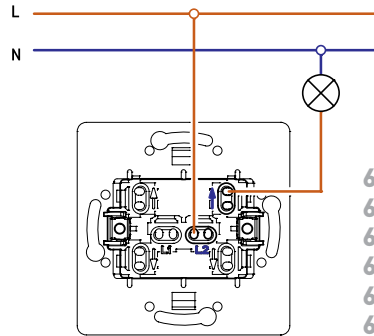
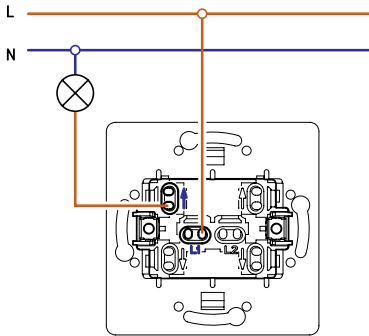

605
609I
610
610I
625
619

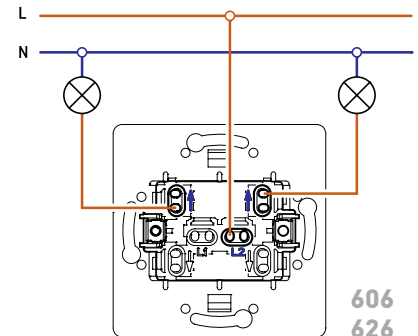

606
626

Jednopolna sklopka ima dve izvedbe sklapanja (leva i desna) i u skladu s tim se povezuju priključni provodnici.

Single-pole switch is supplied in two wiring executions (left and right) and the conductors are connected accordingly.

Serijska sklopka
Serial switch

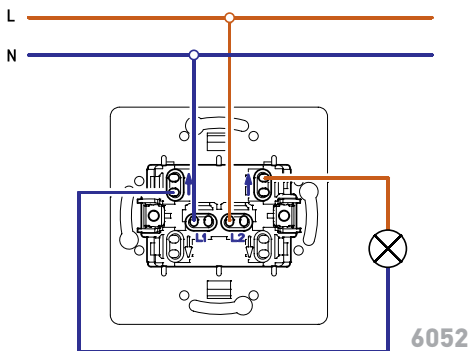

6052

Dvopolna sklopka
Double-pole switch

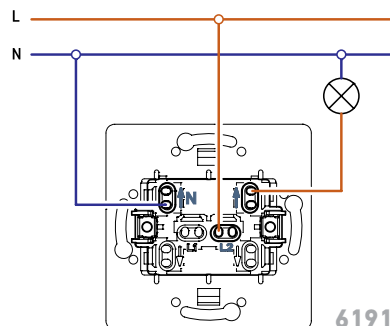

619I

Jednopolne indikatorske sklopke (indikacija svetli kada je sklopka uključena) za povezivanje zahtevaju multi provodnik
Single-pole indication switches (indication turns on when the switch is on) require neutral conductor to be wired.

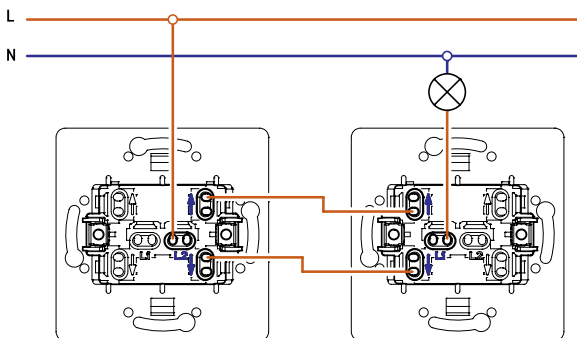

E607
E6072
E627

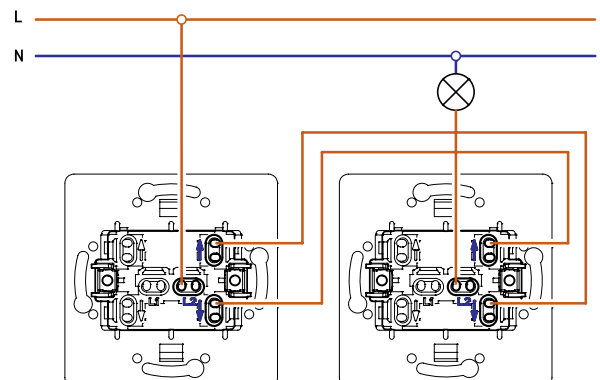

Naizmjenična sklopka, dve izvedbe sklapanja (leva i desna)
Two-way switch, two wiring executions (left and right)

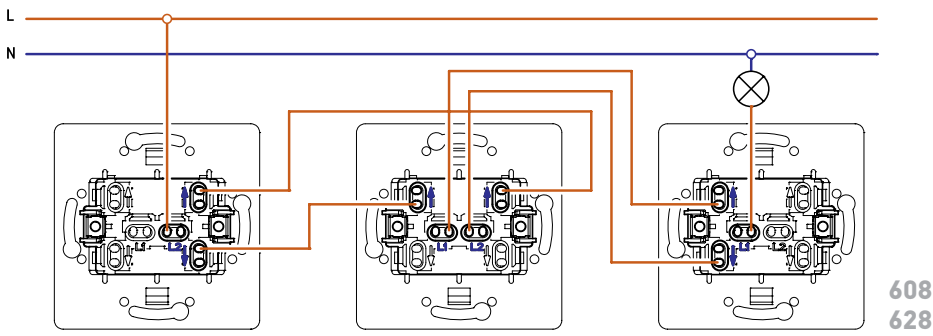

Ukrsna sklopka se povezuje u kombinaciji sa naizmjeničnim sklopkama. Može se povezati neograničen broj ukrasnih sklopki u kombinaciji sa dve naizmjenične.

Intermediate switch is wired in combination with two-way switches. The unlimited number of intermediate switches may be wired in combination with two two-way switches.

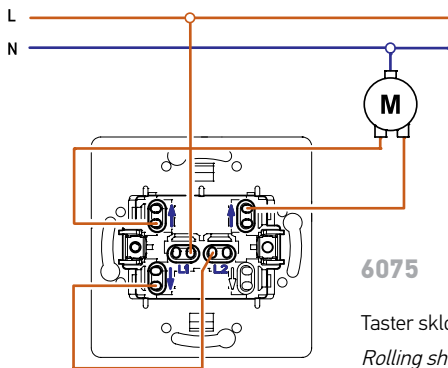

Taster sklopka za roletne
Rolling shutter push-button switch

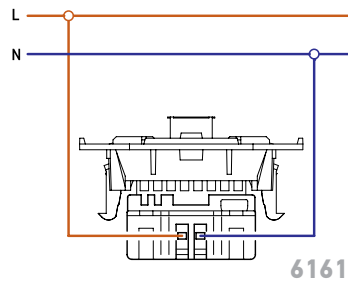

USB punjač
USB charger

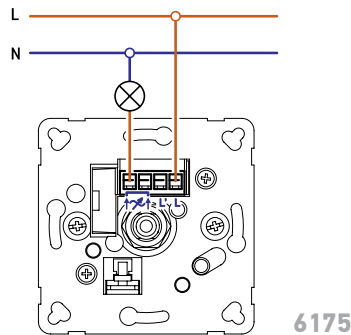
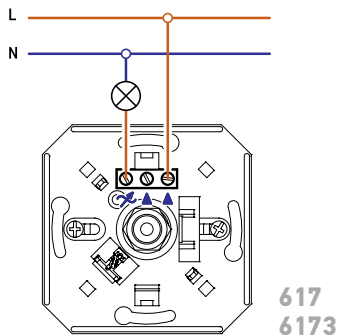

Povezivanje regulatora jačine svetlosti sa naizmjeničnom sklopkom kao jednopolne sklopke i regulatora sa rotacionom jednopolnom sklopkom.

Wiring of dimmer with two-way switch and the dimmer with rotary single-pole switch.

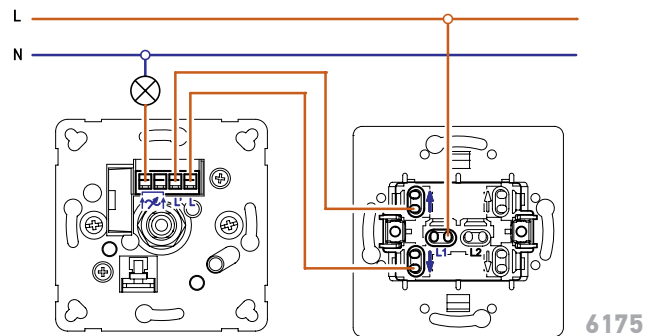
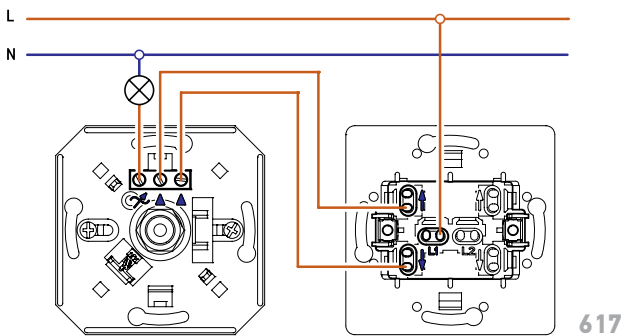

Regulator jačine svetlosti sa naizmjeničnom sklopkom može se povezivati i u kombinaciji sa naizmjeničnom sklopkom za regulaciju sa jednog mesta i uključivanje i isključivanje sa dva mesta. Međusobno povezivanje više regulatora nije moguće.

Dimmer with two-way switch may be also wired in combination with two-way switch for the regulation from one place and switching on and off from two places.

Inter-wiring of more regulators is not possible.

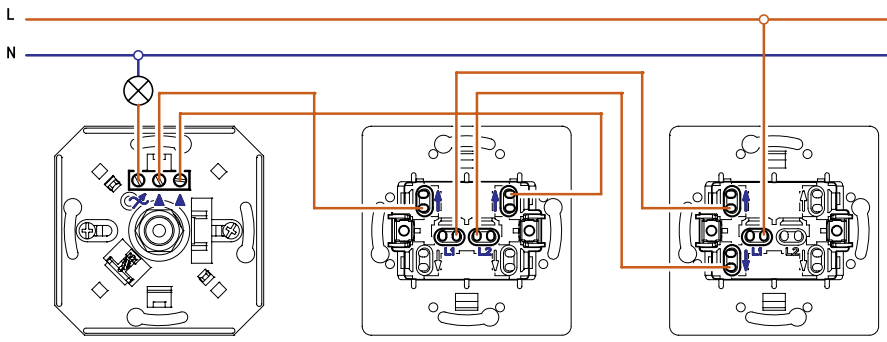

617

Kombinacijom regulatora sa naizmeničnom sklopkom i ukrsne i naizmenične sklopke omogućava se uključivanje i isključivanje sa proizvoljan broj mesta.

The combination of dimer with two-way switch and intermediate and two-way switch provides the switching on and off from the desirable number of places.

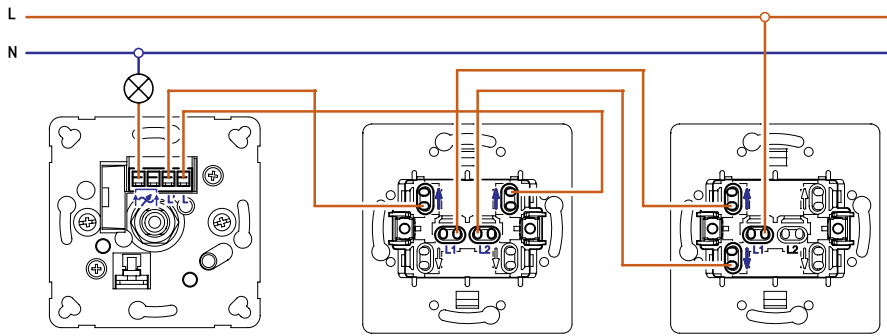

6175

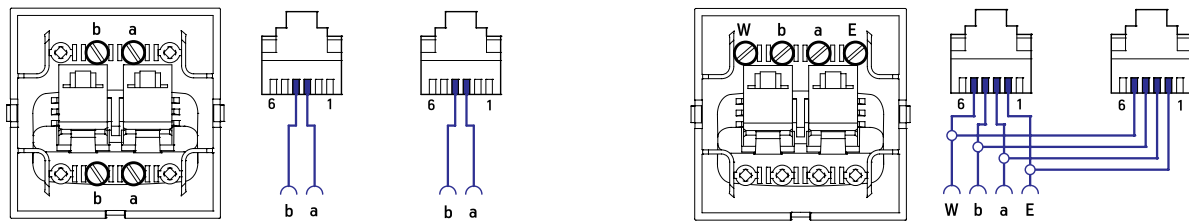

Telefonske priključnice sa standardnim RJ12 konektorima u saglasnosti sa IEC 60603-7 u kombinaciji 2 x 6/2 i 2 x 6/4 kontakta. Povezivanje se vrši prema priloženim šemama gde su kontakti a i b osnovna linija, a W i E kontakti druge parice za analogni terminal (prema internacionalnom standardu).

Telephone sockets with standard RJ12 connectors in compliance with IEC 60603-7 n combination of 2 x 6/2 and 2 x 6/4 contacts. The wiring is carried out in accordance with wiring diagrams where the contacts a and b represent the basic line while W and E are the contacts of the second pair for analogue terminal (according to international standard).

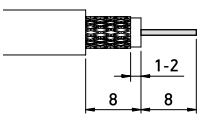

Pripremljen antenski kabl priključujemo pritezanjem u priključnu stezaljku i stezanjem oklopa kabla priteznom papučicom prema datim šemama.

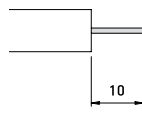

Prepared aerial cable may be installed into terminal and shield tightened by tightening clamp according showed scheme.

Antenski kabl za priključenje na antenske priključnice potrebno je pripremiti prema prikazanoj šemi da bi se postigao siguran kontakt, jednostavno postavljanje i onemogućio eventualni kratak spoj.

For safe contact, simple instaling and short-circuit disabling cable for aerial socket wiring must be prepared according showed scheme.

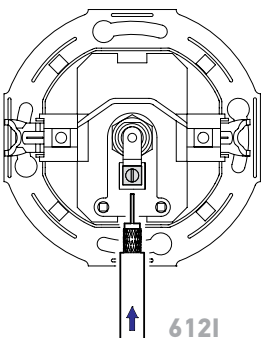

612I

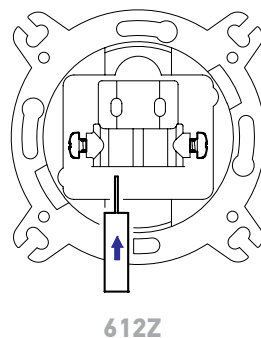

612Z

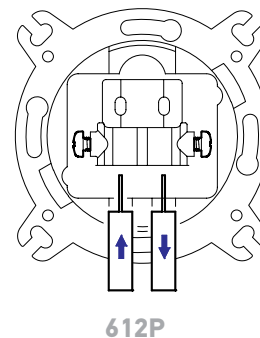

612P

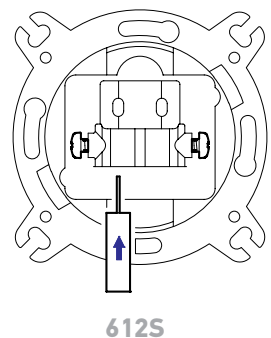

612S

PRESTIGE

DIMENZIJE ZA UGRADNJU INSTALLATION DIMENSIONS

- Osnova maske 80 x 80 mm
- Cover frame base 80 x 80 mm

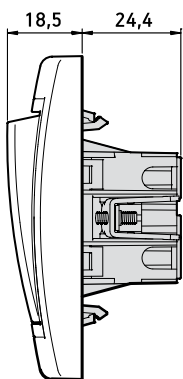
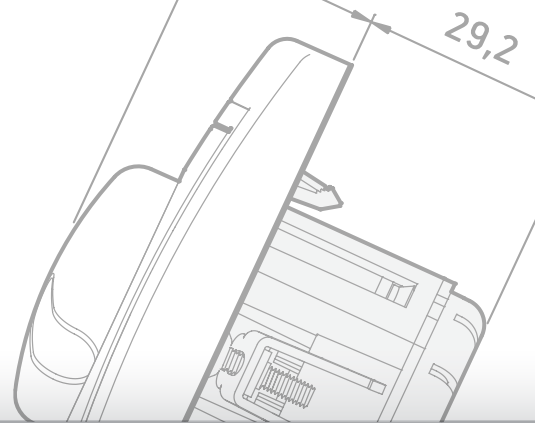

Sklopke
Switches

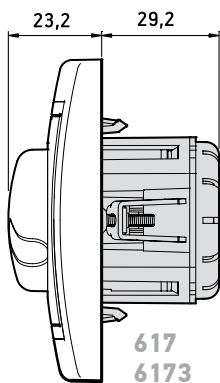

617
6173

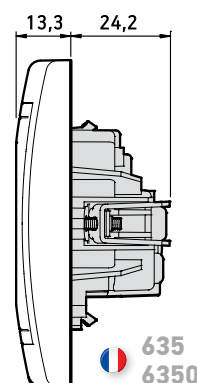

 635
6350

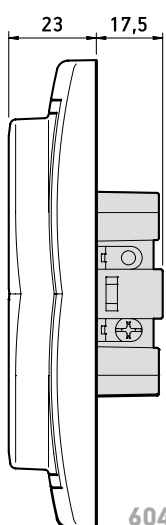

Osnova maske
80 x 123 mm
Cover frame base
80 x 123 mm

604

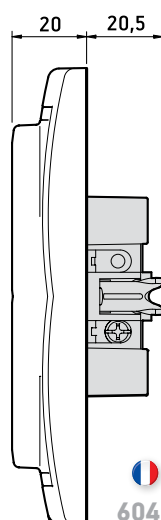

Osnova maske
80 x 123 mm
Cover frame base
80 x 123 mm

 6045

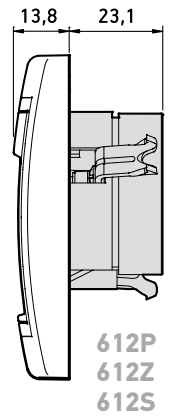
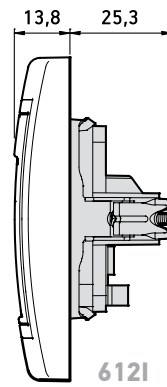
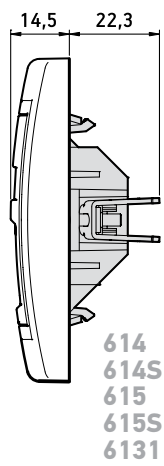
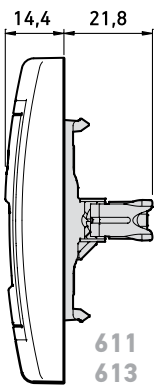
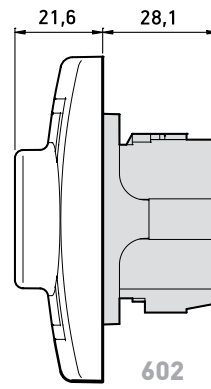
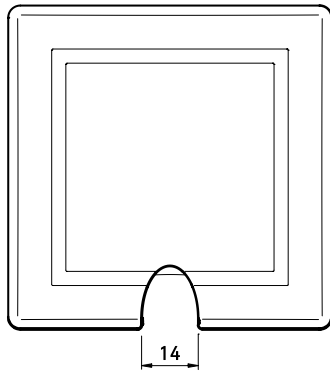
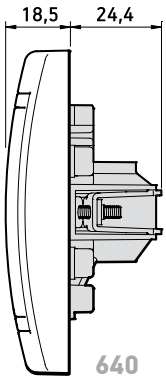
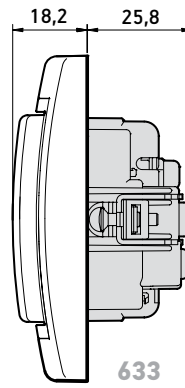
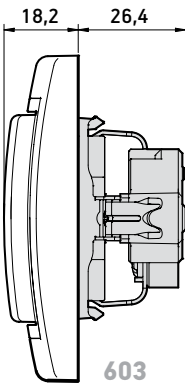
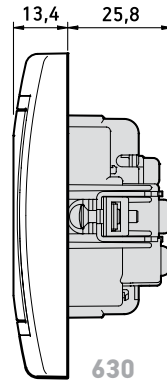
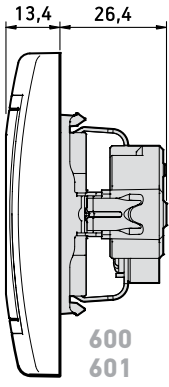

PRESTIGE

TEHNIČKI CRTEŽI TECHNICAL DRAWINGS

- Osnova maske 80 x 80 mm
- Cover frame base 80 x 80 mm

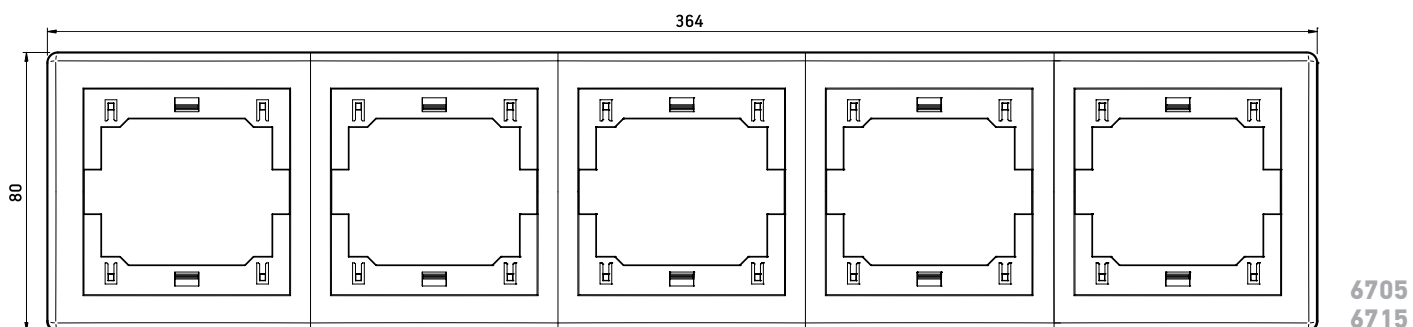
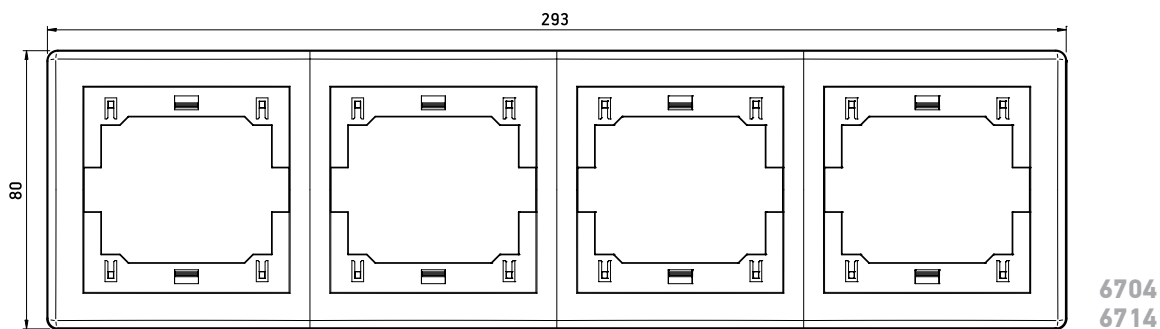
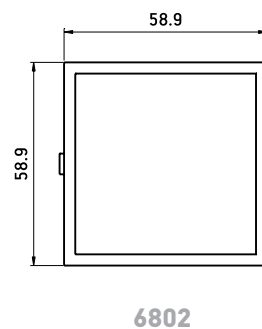
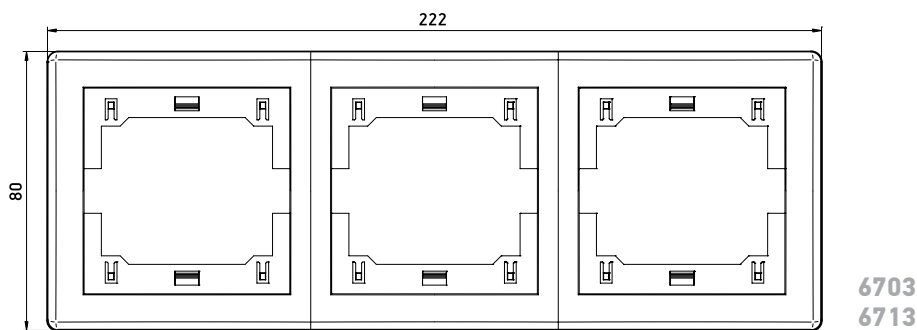
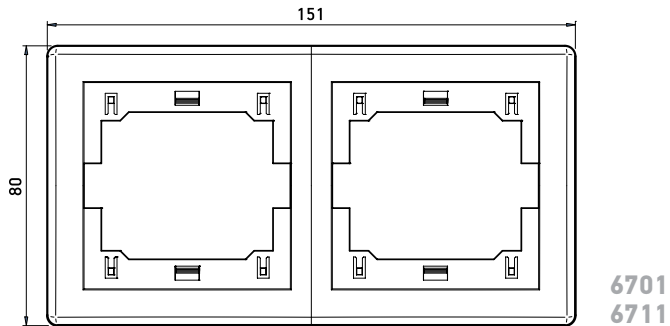
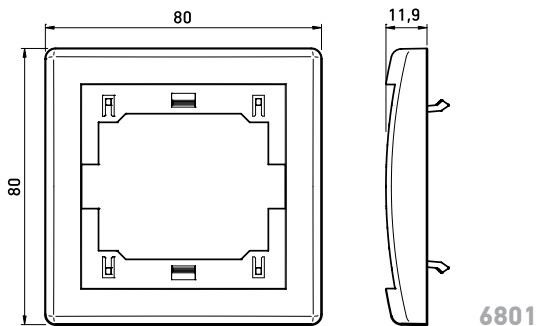
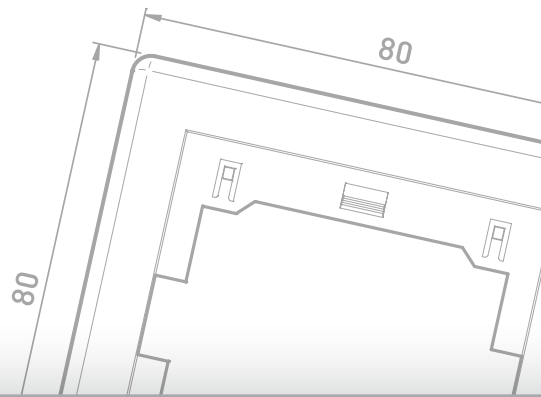

PRESTIGE

SADRŽAJ KATALOGA THE CATALOG CONTENT

- 6 TEHNIČKE PREDNOSTI
TECHNICAL ADVANTAGES
- 7 BOJE PREDNJIH ELEMENATA
FRONT ELEMENTS COLORS
- 8 STANDARDNE BOJE
STANDARD COLORS
- 10 SKLOPKE
SWITCHES
- 12 REGULATORI JAČINE SVETLOSTI
DIMMERS
- 13 PRIKLJUČNICE
SOCKET OUTLETS
- 15 KOMUNIKACIJE
COMMUNICATIONS
- 17 MEHANIZMI BEZ MASKE I MEĐURAMA
MECHANISMS WITHOUT COVER FRAME AND INTERFRAME
- 22 MASKE I MEĐURAMOVI
COVER FRAMES AND INTERFRAMES
- 24 ŠEME VEZIVANJA
WIRING DIAGRAMS
- 27 DIMENZIJE ZA UGRADNJU
INSTALLATION DIMENSIONS
- 29 TEHNIČKI CRTEŽI
TECHNICAL DRAWINGS

PRESTIGE



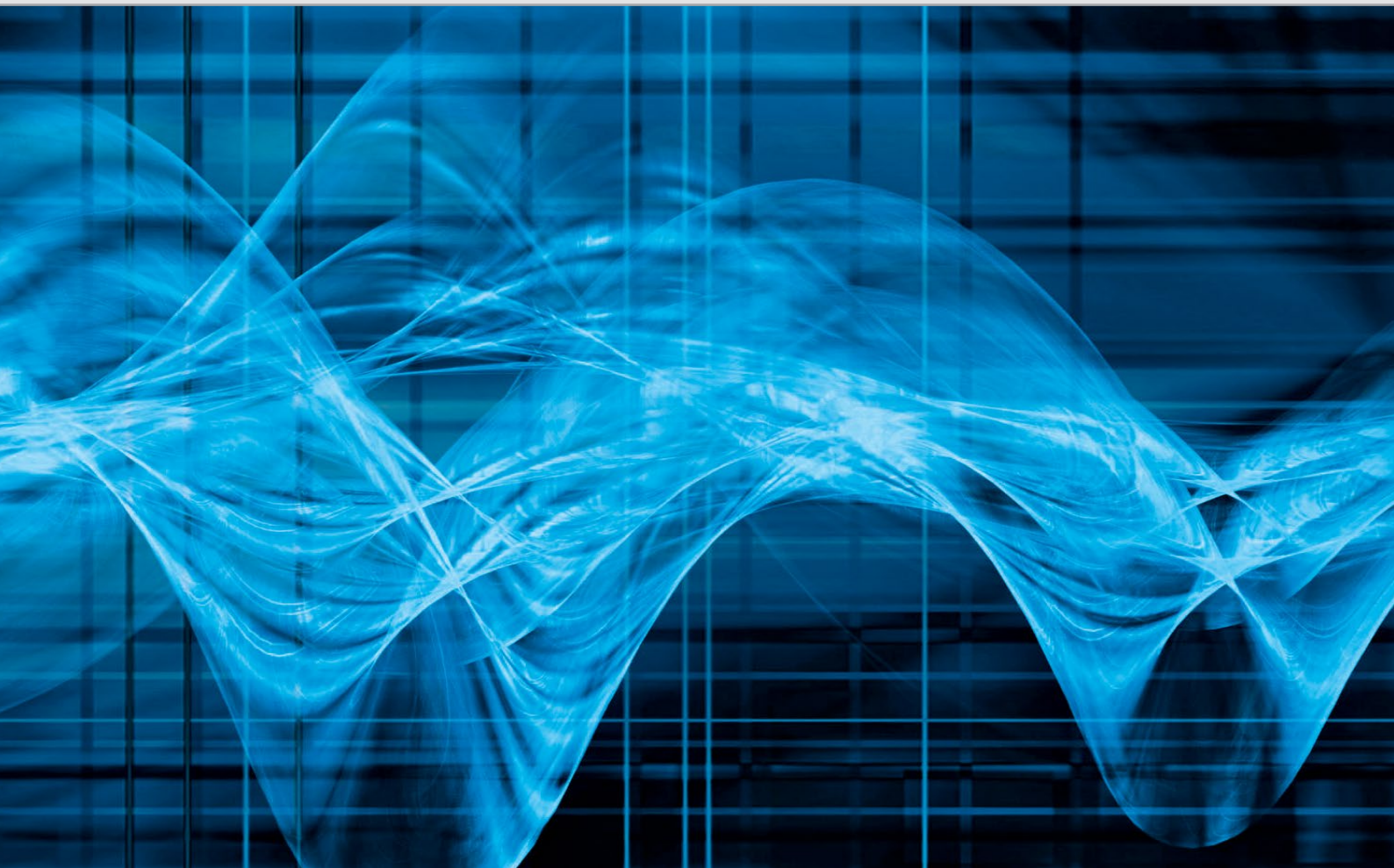

a: Železnička 10, 21432 Gajdobra, Serbia

t: +381 21 762 674, 762 586

f: +381 21 762 779

e: sales@aling-conel.com

www.aling-conel.com